

VRF SYSTEM SIMPLE REMOTE CONTROLLER (WIRED TYPE) UTY-RHK*

English

中文

INSTALLATION MANUAL

For authorized service personnel only.

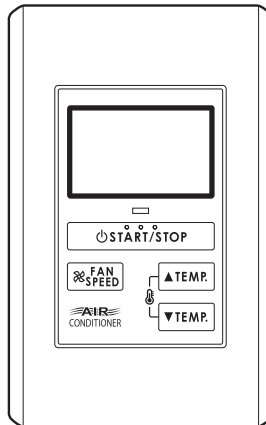

Contents

1. SAFETY PRECAUTIONS	2
2. ACCESSORIES	3
3. ELECTRICAL REQUIREMENT.....	3
4. SELECTING AN INSTALLATION LOCATION	
4.1. Dimensions.....	3
5. INSTALLING THE REMOTE CONTROLLER	
5.1. Installing the remote controller	3
5.2. Setting the DIP Switch.....	4
6. SPECIAL INSTALLATION METHODS	
6.1. Group control.....	5
6.2. Dual remote control	5
7. TURNING ON THE POWER.....	5
8. ADDRESS SETTING	6
9. FUNCTION SETTING	7
10. TEST OPERATION	8
11. ERROR CODE DISPLAY	8

1. SAFETY PRECAUTIONS

- The “SAFETY PRECAUTIONS” indicated in this manual contain important information pertaining to your safety. Be sure to observe them.
- Details of the operation methods refer to the operating manual. Request the user to keep them on hand for future use, such as for relocating or repairing the unit.

 WARNING	This mark indicates procedures which, if improperly performed, might lead to the death or serious injury of the user.
<ul style="list-style-type: none"> • Perform electrical work by an authorized service personnel in accordance with the installation manual and the electrical wiring regulations or implementation regulations of the country. Also do not install this unit by yourself. Improper electric work will cause electric shock or a fire. 	
<ul style="list-style-type: none"> • Perform installation work in accordance with the installation manual. Request an authorized service personnel to perform installation work. Do not install this unit by yourself. Improper installation will cause injury, electric shock, fire, etc. 	
<ul style="list-style-type: none"> • In the event of a malfunction (burning smell, etc.), immediately stop operation, turn off the electrical breaker, and consult authorized service personnel. 	
<ul style="list-style-type: none"> • Install a leakage circuit breaker to power supply cable in accordance with the related laws and regulations and electric company standards. 	
<ul style="list-style-type: none"> • Use a power source exclusively for this unit. Never share the power source with other electrical equipment. Doing so will cause fire and electric shock. 	
<p>Do not install the unit in the following areas:</p> <ul style="list-style-type: none"> • Do not install the unit near a source of heat, steam, or flammable gas. • Area filled with mineral oil or containing a large amount of splashed oil or steam, such as a kitchen. It will deteriorate plastic parts, causing the parts to fall or the unit to leak water. • Area that generates substances that adversely affect the equipment, such as sulfuric gas, chlorine gas, acid, or alkali. It will cause the copper pipes and brazed joints to corrode, which can cause refrigerant leakage. • Area containing equipment that generates electromagnetic interference. It will cause the control system to malfunction, preventing the unit from operating normally. • Area that can cause combustible gas to leak, contains suspended carbon fibers or flammable dust, or volatile inflammables such as paint thinner or gasoline. If gas leaks and settles around the unit, it can cause a fire. • Do not use the unit for special purposes, such as storing food, raising animals, growing plants, or preserving precision devices or art objects. It can degrade the quality of the preserved or stored objects. • Install the unit in a well-ventilated place avoiding rains and direct sunlight. 	





- Do not operate this unit when your hands are wet. Touching the unit with wet hands will cause an electric shock.

- If children may approach the unit, take preventive measures so that they cannot reach the unit.

 CAUTION	This mark indicates procedures which, if improperly performed, might possibly result in personal harm to the user or damage to property.
<ul style="list-style-type: none"> • Pay abundant care when transporting this unit because it is a precision device. Improper transportation will cause trouble. 	
<ul style="list-style-type: none"> • Do not touch the switches with sharp objects. Doing so will cause injury, trouble, or electric shock. 	
<ul style="list-style-type: none"> • Do not expose this unit directly to water. Doing so will cause trouble, electric shock, or heating. 	
<ul style="list-style-type: none"> • Do not set vessels containing a liquid on this unit. Doing so will cause heating, fire, or electric shock. 	
<ul style="list-style-type: none"> • Dispose of the packing materials safely. Tear and dispose of the plastic packing bags so that children cannot play with them. There is the danger of suffocation if children play with the original plastic bags. 	

2. ACCESSORIES

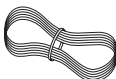
The following installation parts are supplied. Use them as required.

Description	Q'ty	Application
Installation manual 	1	This book
Operating manual 	1	Instruction book for operation
(*) Remote controller cable 	10m	For connecting the remote controller
Screw (M4 x 16mm) 	2	For installing the remote controller
Binder 	1	For remote controller and remote controller cable binding

(*) UTY-RHKYT does not contain cables.

3. ELECTRICAL REQUIREMENT

When connecting the remote controller use the following wiring.

Use	Size	Wire type	Remarks
Remote controller cable	0.33 mm ²	22AWG Polar 3 core, Twisted pair	Use shield cable in accordance with local rules for cable.

* We recommend that you purchase our service parts for the remote controller cable. Contact service personnel to purchase this.

4. SELECTING AN INSTALLATION LOCATION

4.1. Dimensions

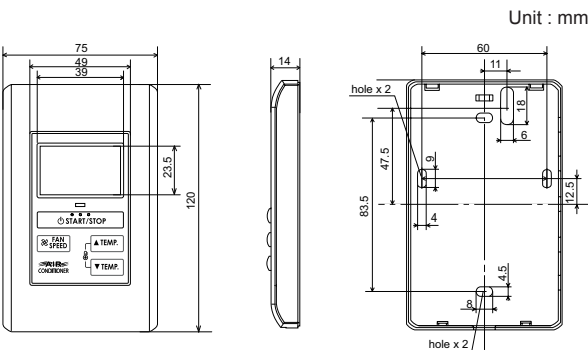

5. INSTALLING THE REMOTE CONTROLLER

⚠ WARNING

- Always use the accessories and specified installation work parts. Check the state of the installation parts. Not using the specified parts will cause units to fall off, water leakage, electric shock, fire, etc.
- Install at a place that can withstand the weight of the unit and install positively so that the unit will not topple or fall.
- When installing this unit, take precautions to prevent access by infants. Otherwise, injury or electric shock could result.
- After installing this unit, perform the test run to confirm that the unit is operating properly. Then, explain the operation of this unit to the customer.

⚠ CAUTION

- Do not set the DIP switch or rotary switch of this unit except as specified in this installation manual or the instruction manual supplied with the air conditioner. Setting the switches other than specified will cause an accident or trouble.
- Before opening the case of this unit, completely discharge static electricity charged on your body. Not doing so will cause trouble.
- Do not touch this unit's circuit board and circuit board parts directly with your hands. Otherwise, injury or electric shock could result.
- Tightening the mounting screws too tight will damage the case of this unit.
- Be careful so that the front cover does not fall after the front cover screws are removed. Otherwise, injury could result.

5.1. Installing the remote controller

Insert the end of a flat blade screwdriver at the ↑ of the groove at the side of the rear case and remove the rear case top by turning the screwdriver.

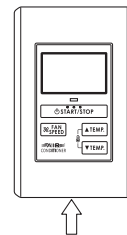

- (1) Pass the remote controller cable through the hole in the rear case and connect the remote controller cable to the remote controller terminal board specified in (Fig. 1).
- (2) Clamp the remote controller cable sheath with the binder as shown in Fig. 1.
- (3) Cut off the excess binder.
- (4) Install the rear case to the wall, box, etc., with two screws. (Fig. 2)

Fig. 1

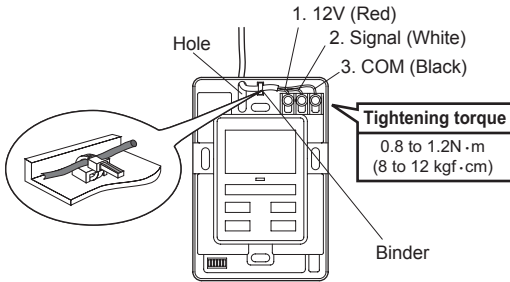
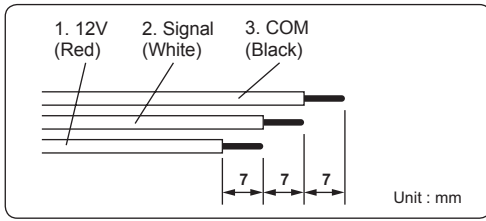

CAUTION
Be careful to avoid breaking the cable by over-tightening the binder.

CAUTION
When connecting the remote controller cables, do not over-tighten the screws.

Fig. 2 [Example]

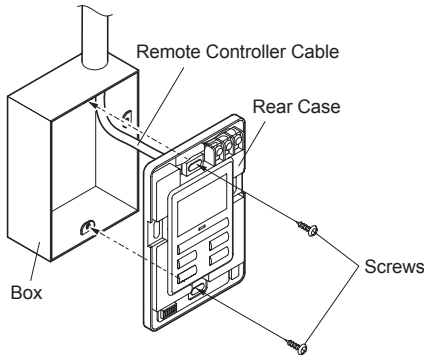

Ground the remote controller if it has a ground cable.

Wrap the connector and remote controller cables with vinyl tape or some other type of insulation as shown in the figure.

Remote controller

5.2. Setting the DIP switch

Set the remote controller DIP switches. (Fig. 1)

Fig. 1 [Example]

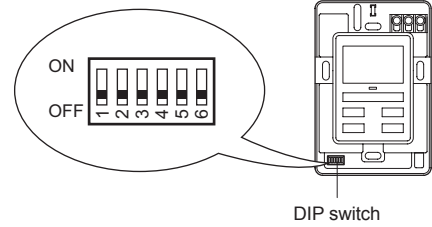

	NO.	SW state		Detail
		OFF	ON	
DIP Switch	1	★ Fixed at OFF		Cannot be used
	2	★ MASTER	SLAVE	Refer to 6 SPECIAL INSTALLATION METHODS.
	3	★ Fixed at OFF		Cannot be used
	4	★ Fixed at OFF		Cannot be used
	5	★ Fixed at OFF		Cannot be used
	6	★ Fixed at OFF		Cannot be used

(★ Factory setting)

6. SPECIAL INSTALLATION METHODS

WARNING

- Before starting installation work, turn off the power of this unit and the connection destination. Do not turn on the power again until installation is completed. Otherwise, it will cause electric shock or fire.
- Use the accessories or specified power cable and connection cables. Do not modify power cable and connection cables other than those specified, do not use extension cords, and do not use independent branch wiring. The allowable current will be exceeded and cause electric shock or fire.
- Install the connection cables securely to the terminal board. Confirm that external force is not applied to the wire. Use connection cables made of the specified wire. If intermediate connection or insertion fixing are imperfect, it will cause electric shock, fire, etc.
- When connecting the power cable and communication cable, layout the wiring so that the cover of this unit is securely fixed. If the cover is imperfectly fixed, it may cause fire or overheating of the terminals.
- Perform ground work positively. Do not connect the ground wire to a telephone ground wire, water pipe, or conductor rod.
- Always fasten the outside covering of the connection cord with the cord clamp. (If the insulator is chafed, electric leakage may occur.)
- When performing cable wiring work, be sure that it does not touch the user. Doing so will cause injury or electric shock.
- If any cable is damaged, do not repair or modify it yourself. Improper work will cause electric shock or fire.

CAUTION

- Do not wire the remote controller cable and the transmission cable together with or parallel to the connection cable, transmission cables, and power supply cables of the indoor and outdoor units. It may cause erroneous operation.
- When performing wiring work, be careful not to damage the cable or injure yourself. Also, connect the connectors securely. Loose connectors will cause trouble, heating, fire, or electric shock.
- Install the indoor and outdoor units, power cable, signal cable and remote control cable 1 m away from television and radio to avoid distorted images and noise.
- Perform wiring so that water does not enter this unit along the external wiring. Always install a trap to the wiring or take other countermeasures. Otherwise it will cause trouble or electric shock or fire.
- Confirm the name of each unit and name of each terminal board of the unit and connect the wiring in accordance with the directions given in the manual so that there is no incorrect wiring. Incorrect wiring will damage the electric parts and cause smoke and fire.
- When installing the connection cable near a source of electromagnetic waves, use shielded cable. Otherwise, a breakdown or malfunction could result.

6.1. Group control

A number of indoor units can be operated at the same time using a single remote controller.

(1) Wiring method (indoor unit to remote controller)

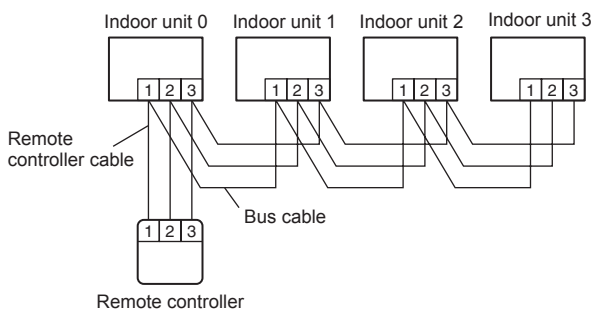

• When there are ground cables

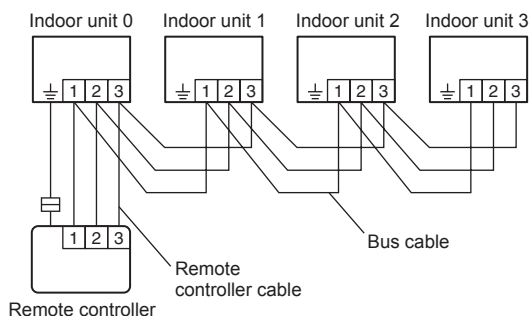

(2) Indoor unit rotary switch setting

Set each remote controller address in order from 0 using the rotary switch of each indoor unit.

(Refer to the installation manual for the indoor unit.)

Up to 16 indoor units can be connected.

6.2. Dual remote control

- Two remote controllers can be used to operate the indoor units.
- The self-diagnosis functions cannot be used on the slave units.
- The remote controller (UTB-*LA) and remote controller (UTB-*P*) cannot be connected at the same time.

(1) Wiring method (indoor unit to remote controller)

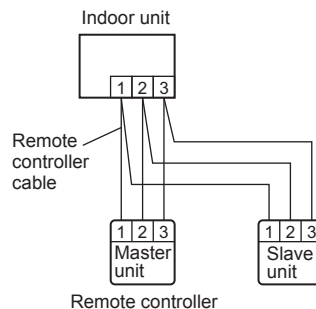

• When there are ground cables

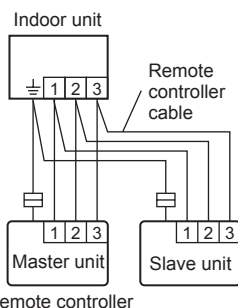

(2) Remote controller DIP switch setting

Set the remote controller DIP switch No. 2 according to the following table.

Number of remote controllers	Master unit DIP-SW No. 2	Slave unit DIP-SW No. 2
1 (Normal)	OFF	-
2 (Dual)	OFF	ON

- Group control and dual remote control can be used together.
- When connecting 2 remote controllers, the simple remote controller can also be connected together with another type of remote controller.

7. TURNING ON THE POWER

CAUTION

- Before turning on the power, check that the voltage is within the rated range. If operated outside the rated range, erroneous operation cannot be prevented and cannot be compensated.

- (1) Check the remote controller wiring and DIP switch settings.
- (2) Check the indoor and outdoor unit wiring and circuit board switch settings, and then turn on the indoor and outdoor units.
- (3) After "9E" has flashed on the set temperature display for several second, the  mark will be displayed in the center of the remote controller display.

* For the wiring and circuit board switch settings method, refer to the installation manual for the indoor unit and outdoor unit.

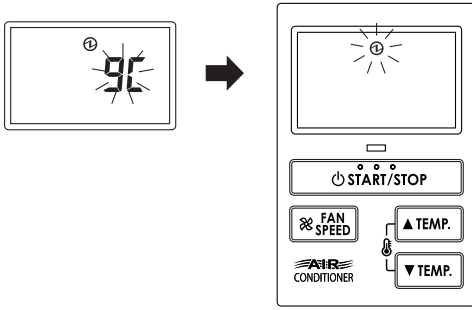

8. ADDRESS SETTING

Address setting method can be selected from 3 options, outdoor unit, indoor unit and remote controller.

Refer to the installation manual of outdoor unit or indoor unit when set up from the outdoor unit or the indoor unit.

- "Indoor unit address" and "Refrigerant circuit address" can be set using the Simple remote controller.
- This function can be set in all indoor units when the Simple remote controller is connected.
- "Remote controller address" cannot be set in this function. Ensure to set with the Rotary SW of PCB of the indoor unit.
- When setting the address of indoor unit, refer to installation manual of indoor unit.
- When setting the address of outdoor unit automatically, refer to installation manual of outdoor unit.
- When setting the address with a remote controller, refer to installation manual of indoor unit for setting details of indoor unit.

Switching selection of address setting mode

- (1) Press "▲TEMP." button, "▼TEMP." button, and "FAN SPEED" for more than 5 seconds simultaneously. Then shift to Address setting mode.

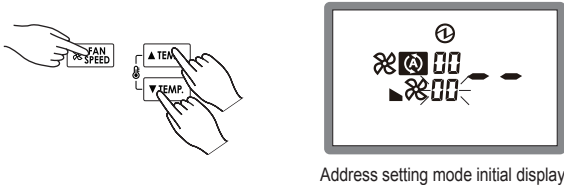

- (2) Press "▲TEMP." button or "▼TEMP." button and select the Remote controller address (Select the relevant indoor unit).

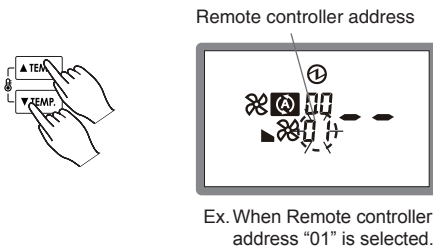

Indoor unit address setting

- (3) "Address code" display blinks. Then display Address code "01" by pressing "▲TEMP." button or "▼TEMP." button.

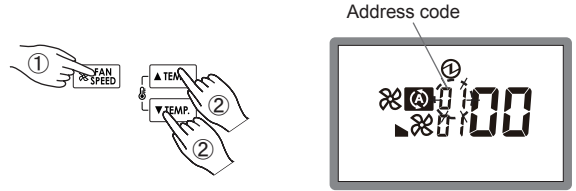

- (4) When the "Address data" blinks by pressing "FAN SPEED" button set the Indoor unit address data by pressing "▲TEMP." button or "▼TEMP." button. (Range of setting is 00-63.)

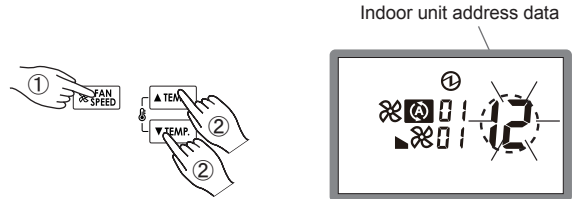

- (5) Fix the Indoor unit address data by pressing "START/STOP" button. (Data is transferred to the indoor unit).

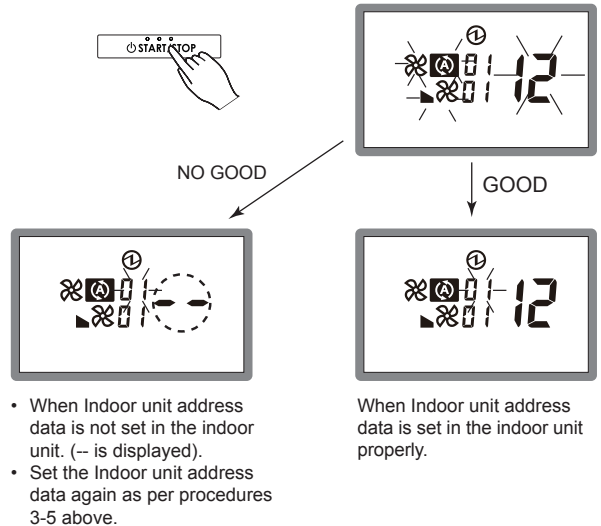

- (6) When the "Address code" blinks by pressing "FAN SPEED" button set the Address code "02" by pressing "▲TEMP." button or "▼TEMP." button.

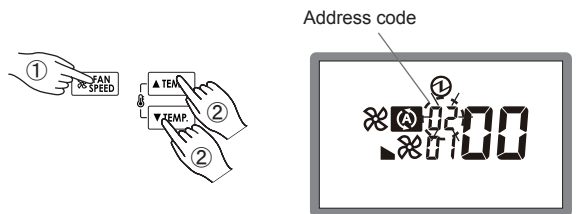

Refrigerant circuit address setting

- (7) "Address data" display blinks. Then set the Refrigerant circuit address data by pressing "▲TEMP." button or "▼TEMP." button. (Range of setting is 00-99.)

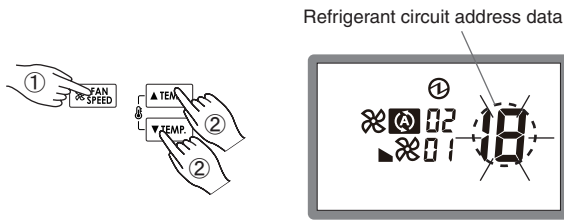

Ex. When Refrigerant circuit address "18" is selected.

- (8) Fix the Refrigerant circuit address data by pressing "START/STOP" button. (Data is transferred to the indoor unit).

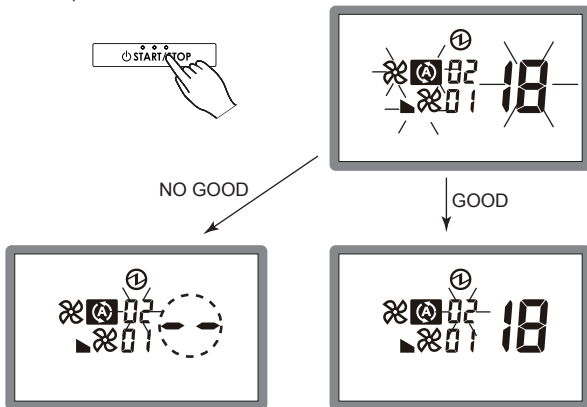

- When Refrigerant circuit address data is not set in the indoor unit. (-- is displayed).
- Set the Refrigerant circuit address data again as per procedure 8 above.

When Refrigerant circuit address data is set in the indoor unit properly.

Completion of address setting mode

- (9) Address setting mode is released and returns to normal display if "▲TEMP." button, "▼TEMP." button and "FAN SPEED" button are pressed for more than 5 seconds simultaneously.

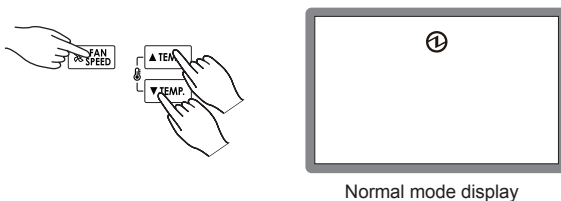

Normal mode display

- * Address setting mode is released automatically if no key is pressed for 60 seconds even the above buttons are not pressed.
- (Switch to Address setting mode as per procedure 1 above. It is automatically released when Address setting)

- (10) After completing the FUNCTION SETTING, be sure to turn off the power and turn it on again.

9. FUNCTION SETTING

This procedure changes the function settings used to control the indoor unit according to the installation conditions. Incorrect settings can cause the indoor unit to malfunction. This procedure should be performed by authorized installation or service personnel only.

Perform the "FUNCTION SETTING" according to the installation conditions using the remote controller.

- Refer to the indoor unit installation manual for details on the function numbers and setting numbers.
- Prepare for setting of indoor unit referring to installation manual of indoor unit before start of functional setting.

Start of Function setting mode

- (1) Press "▲TEMP." button, "▼TEMP." button, and "FAN SPEED" for more than 5 seconds simultaneously. Then shift to Function setting mode.

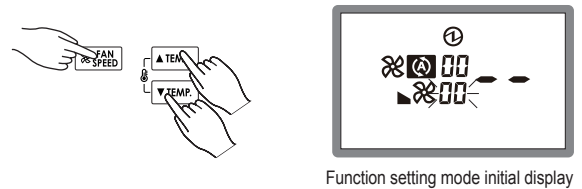

Function setting mode initial display

- (2) Press "▲TEMP." button or "▼TEMP." button and select the Remote controller address (Select the relevant indoor unit).

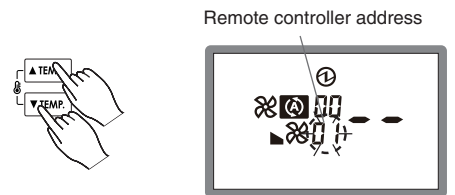

Ex. When Remote controller address "01" is selected.

Function number and setting number setting

- (3) "Function number" display blinks. Then display Number by pressing "▲TEMP." button or "▼TEMP." button.

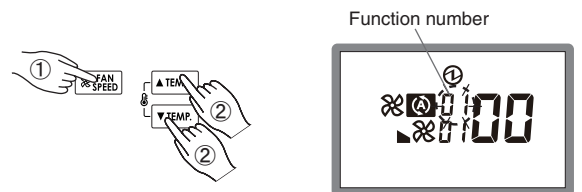

Function number

- (4) When the "Setting number" blinks by pressing "FAN SPEED" button set the Setting number by pressing "▲TEMP." button or "▼TEMP." button.



Setting number

Ex. When Setting number "12" is selected.

- (5) Fix the setting by pressing the "START/STOP" button.
(Data is transferred to the indoor unit).

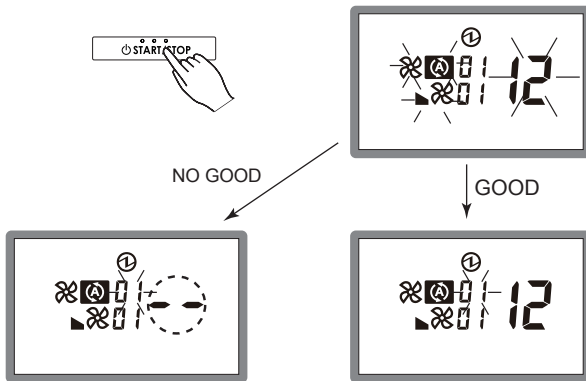

- (-- is displayed,) if not set the indoor unit.
- Set again as per procedures 3-5 above.

When set properly in the indoor unit.

Completion of address setting mode

- (6) Function setting mode is released and returns to normal display if "▲TEMP." button, "▼TEMP." button and "FAN SPEED" button are pressed for more than 5 seconds simultaneously.

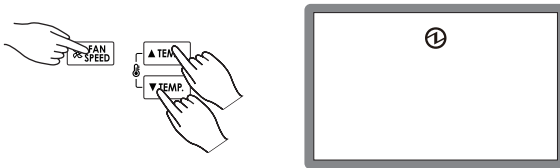

Normal mode display

- * Function setting mode is released automatically if no key is pressed for 60 seconds even the above buttons are not pressed.

(Switch to Function setting mode as per procedure 1 above. It is automatically released when Function setting)

- (7) After completing the FUNCTION SETTING, be sure to turn off the power and turn it on again.

10. TEST OPERATION

This unit does not activate the test operation. Test operation can be activated by the other remote controllers.

Run [Self-Diagnosis] if [Er] flashes on the display of the remote controller.

11. ERROR CODE DISPLAY

If there is a problem with the air conditioner, it will stop running and "Er" will be displayed.

If an error occurs, it appears automatically on the display as shown on the right.

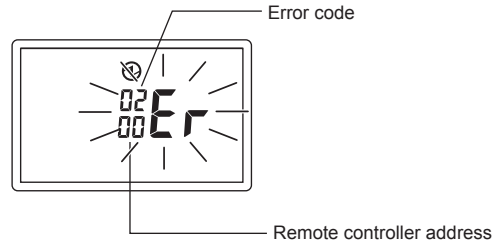

If "Er" is displayed, immediately contact authorized service personnel.

Do not use the operation below if an error has occurred.

- For an error with the indoor unit, refer to the indoor unit installation manual.

Unit number	Error code	Content
00	15	Incompatible indoor unit is connected
00	12	Indoor unit ↔ remote controller communication error

VRF 系统 简易遥控器 (有线式) UTY-RHK*

安装说明书

只供授权专业维修人员使用。

文
母

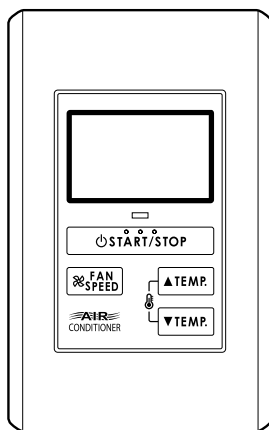



目录

1. 安全注意事项.....	2
2. 附件.....	3
3. 电气要求.....	3
4. 选择安装位置	
4.1. 尺寸.....	3
5. 安装遥控器	
5.1. 安装遥控器.....	3
5.2. 设定 DIP 开关.....	4
6. 特殊安装方法	
6.1. 群组控制.....	5
6.2. 双遥控器.....	5
7. 接通电源.....	5
8. 地址设定.....	6
9. 功能设定.....	7
10. 试运行.....	8
11. 故障代码显示.....	8

1. 安全注意事项





- 本手册中出现的“安全注意事项”包含与您的安全有关的重要信息。务必遵守这些信息。
- 有关操作方法的详细信息，请参见使用说明书。请用户将这些警告和注意事项保存在手边，以备将来机组迁移或维修时使用。

 警告	本标志表示如果操作失当可能会导致用户死亡或严重伤害。
<ul style="list-style-type: none"> • 电气工作应由授权的维修人员按照安装说明书和国家的电气接线规范或实施规范进行。另外，请勿自行安装本机组。电气工作不当会导致触电或火灾。 	
<ul style="list-style-type: none"> • 请按照安装说明书进行安装工作。请授权的维修人员进行安装工作。请勿自行安装本机组。安装不当会导致人身伤害、触电、火灾等。 	
<ul style="list-style-type: none"> • 当本机组出现故障（发出燃烧气味等）时，应立即停止操作，关闭断路器，并与授权专业维修人员接洽。 	
<ul style="list-style-type: none"> • 根据有关法规和电力公司的标准在电源线上安装漏电断路器。 	
<ul style="list-style-type: none"> • 请使用本机组专用的电源。切勿与其它电气设备共用一个电源。否则会导致火灾和触电。 	
<p>请勿将机组安装在以下地方：</p> <ul style="list-style-type: none"> • 请勿将机组安装在靠近热源、蒸汽或易燃气体的地方。 • 充满矿物油或含有大量飞溅油或蒸汽的地方，例如厨房。这样会使塑料零件变质，导致零件坠落或机组漏水。 • 能产生对设备有不利影响的物质（例如含硫气体、氯气、酸或碱）的地方。会导致铜管和铜焊接头腐蚀，引起制冷剂泄漏。 • 有能产生电磁干扰的设备的地方。会引起控制系统故障，妨碍机组正常运行。 • 能导致可燃气体泄漏、含有悬浮碳纤维、易燃粉尘或挥发性易燃物（如油漆稀释剂或汽油）的地方。如果气体泄漏并聚积在机组周围，会导致火灾。 • 请勿将机组用于存放食品、饲养动物、种植植物或保存精密设备或工艺品等特殊用途。这样会影响所保存或存放的物品质量。 • 将机组安装在通风良好之处，避免雨淋和阳光直射。 	
<ul style="list-style-type: none"> • 请勿在手湿时操作本机组。用湿手触摸机组会导致触电。 	
<ul style="list-style-type: none"> • 如儿童有可能接近机组时，请采取适当的预防措施，使他们无法接触到机组。 	

 注意	本标志表示如果操作失当可能会对用户的人身受到伤害或财产受到损失。
<ul style="list-style-type: none"> • 运输本机组时要特别小心，因为它属于精密设备。运输不当会引起故障。 	
<ul style="list-style-type: none"> • 请不要用尖锐的物体触摸开关。否则会导致人身伤害、故障或触电。 	
<ul style="list-style-type: none"> • 请勿让本机组直接置于有水的环境中。否则会导致故障、触电或发热。 	
<ul style="list-style-type: none"> • 请勿将装有液体的容器放在本机组上。否则会导致发热、火灾或触电。 	
<ul style="list-style-type: none"> • 请安全处置包装材料。将塑料包装袋撕碎并丢弃，使儿童无法用其玩耍。如果儿童拿着未撕开的塑料袋玩耍，会有窒息的危险。 	

2. 附件

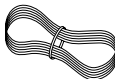
提供下列安装部件，请按需要使用。

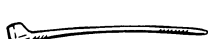
说明	数量	用途
安装说明书 	1	本书
使用说明书 	1	操作的说明书
(*) 遥控器电线 	10m	用于连接遥控器
螺钉 (M4 x 16mm) 	2	用于安装遥控器
绑扎件 	1	用于绑扎遥控器和遥控器电线

(*) UTY-RHKYT 不包含电线。

3. 电气要求

连接遥控器时使用下列接线。

用途	尺寸	电线类型	备注
遥控器电线	0.33 mm ²	22AWG 极性 3 芯， 双绞线	按照当地有关电线的法规使用屏蔽电缆。

* 建议购买本公司的遥控器电线维修部件。如要购买部件，请与服务代表接洽。

4. 选择安装位置

4.1. 尺寸

单位：mm

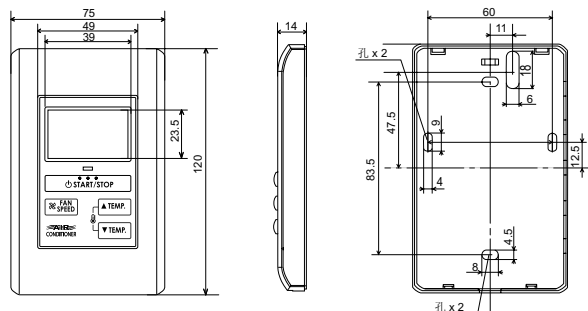

5. 安装遥控器

警告

- 务必使用附件和指定的安装工作零件。检查安装零件的状态。若不使用指定的零件，会导致机组坠落、漏水、触电、火灾等。
- 应选择可以完全支撑机组重量的地方进行安装，并将机组安装牢固，以免倾倒或坠落。
- 当安装本机时，注意避免幼童接近。否则，可能会导致人身伤害或触电。
- 安装本机后，执行试运行以确定本机运行正常。然后，向客户说明本机的操作。

注意

- 切勿设定本机组的 DIP 开关或旋转开关，除非是本安装说明书或空调附带的说明书所规定的。若在规定以外设定开关，会导致事故或故障。
- 打开本机组的壳体之前，请排净您身上所带的静电。否则会导致故障。
- 请勿用手直接触摸本机的电路板和电路板部件。否则，可能会导致人身伤害或触电。
- 将安装螺钉拧得过紧会损坏本机组的壳体。
- 小心不要在拆下前盖螺钉后使前盖掉落。否则，可能会导致人身伤害。

5.1. 安装遥控器

将平头螺丝刀的尖端插在后壳侧面槽上的 ↑ 部位，转动螺丝刀拆下后壳的顶盖。

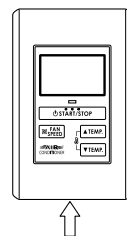

- (1) 将遥控器电线穿过后壳的孔并连接到 (图 1) 中所示的遥控器接线板上。
- (2) 如图 1 所示，用扎带将遥控器电线护套夹住。
- (3) 剪去绑扎件多余的部分。
- (4) 用两枚螺钉将后盖安装在墙上，安装盒或其他部位。(图 2)

图 1



图 2 [示例]



5.2. 设定 DIP 开关

请设定遥控器的 DIP 开关。(图 1)

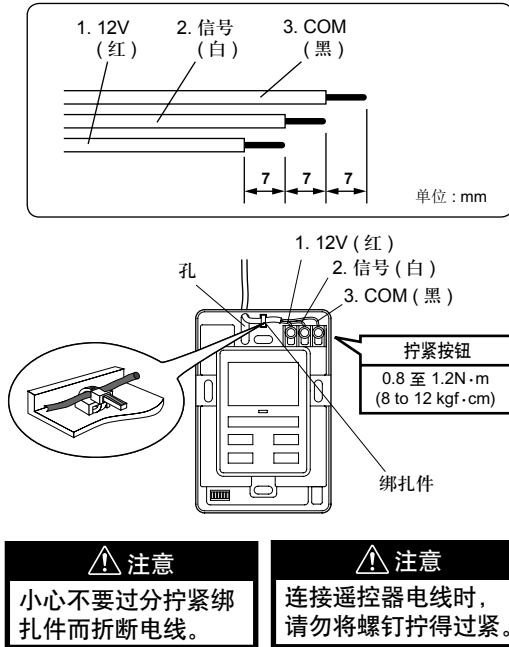
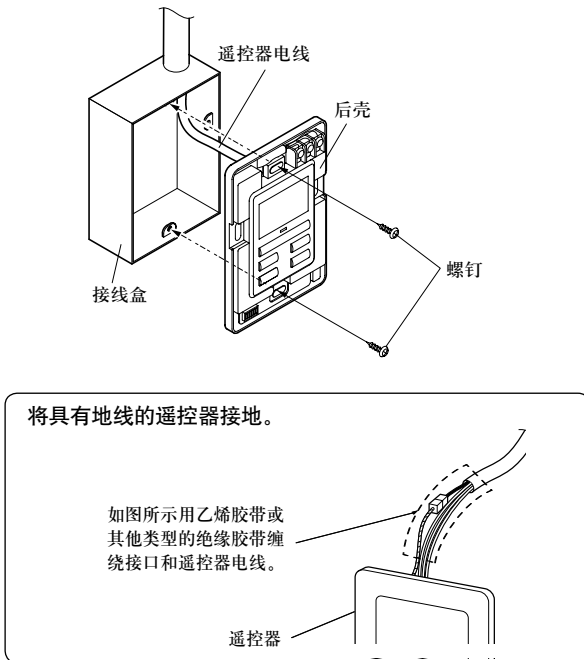
图 1 [示例]

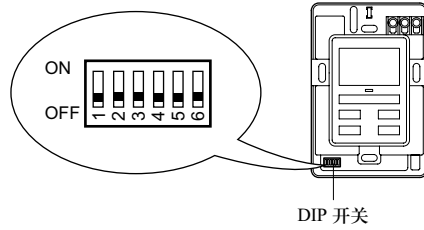

	编号	SW 状态		说明
		OFF (关)	ON (开)	
DIP 开关	1	★ 固定在关		无法使用
	2	★ 主机	子机	请参阅 6 特殊安装方法。
	3	★ 固定在关		无法使用
	4	★ 固定在关		无法使用
	5	★ 固定在关		无法使用
	6	★ 固定在关		无法使用

(★ 出厂设定)

6. 特殊安装方法

警告

- 开始安装工作之前，请关闭本机组的电源和连接目的地。请不要在安装工作尚未完成时就打开电源。否则会导致触电或火灾。
- 请使用附件或指定电源线和连接线。请勿改装规定以外的电源线和连接线，请勿使用延长线，请勿使用独立的分支线路。否则会增加允许的电流，导致触电或火灾。
- 将连接线牢固地安装在接线板上。确认不会有外力施加在电线上。请使用用指定电线制成的连接线。如果中间连接或插入固定不当，会导致触电、火灾等。
- 连接电源线和通信线时，线路的布线应确保本机组的机盖固定牢固。如果机盖固定不牢固，会导致火灾或端子过热。
- 要正确进行接地工作。请勿将地线连接到电话地线、水管或导体棒上。
- 必须用线夹固定连接线的绝缘层。(如果绝缘层被擦破，可能会发生漏电。)
- 进行电线接线工作时，务必不要触摸用户。否则会导致人身伤害或触电。
- 如果电线损坏，不要自行维修或改装。工作不当会导致触电或火灾。

注意

- 请勿将遥控器电线和传输线与室内 / 室外机的连接线、传输线和电源线连接在一起或并联。这可能会导致运行故障。
- 进行接线工作时，小心不要损坏电线或弄伤您自己。同时牢固地接好插头。插头不牢固会导致故障、发热、火灾或触电。
- 安装室内 / 室外机、电源线、信号线和遥控电线时，应距离电视机和收音机 1 m 远，以避免图像失真和噪音。

- 进行接线时，要确保水不会顺着外部线路进入本机组中。务必在线路上安装除水弯头或采取其它应对措施。否则会导致故障、触电或火灾。
- 确认每台机组的名称和机组每块端子板的名称，并按照说明书规定的方向连接线路，确保不会发生接线错误。接线错误会损坏电气零件，引起烟雾和火灾。
- 在电磁波发生源附近安装连接线路时，请使用屏蔽线。否则会导致击穿或故障。

6.1. 群组控制

您可以使用一个遥控器同时操作多台室内机。

(1) 接线方法 (由室内机至遥控器)

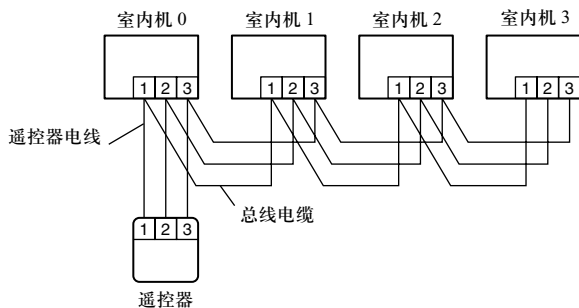

• 具有地线时

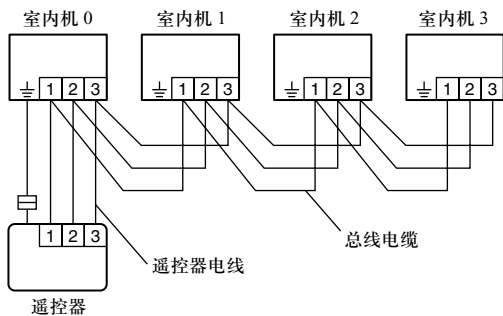

(2) 室内机的旋转开关设定

用每台室内机的旋转开关从 0 开始依次设定每个遥控器地址。

(请参见室内机安装说明书。)

最多可以连接 16 台室内机。

6.2. 双遥控器

- 可以使用 2 个遥控器操作室内机。
- 子机无法使用定时器功能和自检功能。
- 不可同时连接遥控器 (UTB-*LA) 和遥控器 (UTB-*P*)。

(1) 接线方法 (由室内机至遥控器)

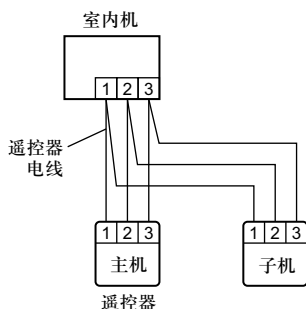

• 具有地线时

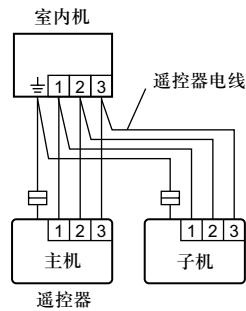

(2) 遥控器的 DIP 开关设定

请按照下表，设定遥控器的 DIP 开关 2。

遥控器的数目	主机	子机
	DIP 开关 2	DIP 开关 2
1 (单控)	关	-
2 (双控)	关	开

- 可以同时使用组控制和双遥控。
- 连接 2 个遥控器时，也可以将简易遥控器与另一类型的遥控器一起连接。

7. 接通电源

⚠ 注意

- 打开电源前，检查电压是否在额定范围之内。如果超过额定范围运行，运行故障将无法避免，也无法进行补偿。

- (1) 检查遥控器的接线和 DIP 开关设定。
 - (2) 检查室内和室外机的接线以及电路板的开关设定，然后接通室内和室外机的电源。
 - (3) “9C” 在设定温度显示屏闪烁数秒后，遥控器的显示屏中央会显示 ① 标志。
- * 有关接线和设定电路板开关的方法，请参阅室内机和室外机的安装说明书。

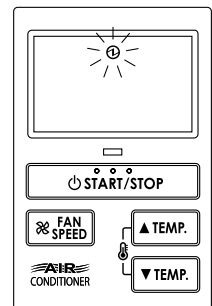

8. 地址设定

有 3 种地址设定方法可供选择：室外机、室内机和遥控器。
从室外机或室内机进行设定时，请参见室外机或室内机的安装说明书。

- 可以使用简易遥控器设定“室内机地址”和“制冷剂回路地址”。
- 连接简易遥控器时，可以在所有室内机中设定此功能。
- 无法在此功能中设定“遥控器地址”。
确保使用室内机的旋转开关设定。
- 设定室内机的地址时，请参阅室内机的安装说明书。
- 自动设定室外机的地址时，请参阅室外机的安装说明书。
- 使用遥控器设定地址时，请参阅室内机的安装说明书以了解室内机的设定详情。

地址设定模式的切换选择

- (1) 同时按“▲TEMP.”按钮、“▼TEMP.”按钮和“FAN SPEED”按钮 5 秒钟以上。切换到地址设定模式。

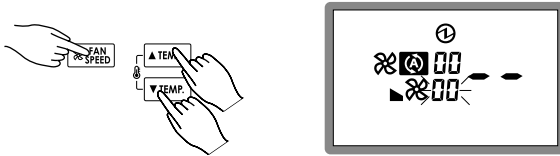

地址设定模式初始显示

- (2) 按“▲TEMP.”按钮或“▼TEMP.”按钮，然后选择遥控器地址（选择相应的室内机）。

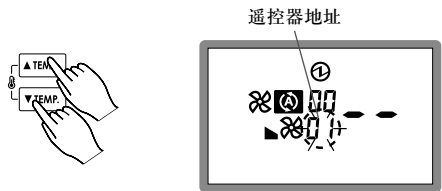

遥控器地址

例) 选择了遥控器地址“01”时。

室内机地址设定

- (3) “地址代码”显示闪烁。然后按“▲TEMP.”按钮或“▼TEMP.”按钮显示地址代码“01”。

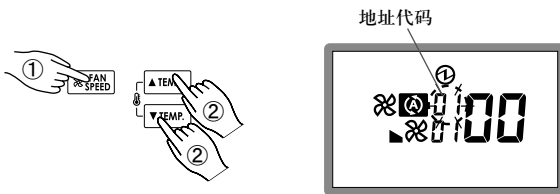

地址代码

例) 选择了制冷剂回路地址“18”时。

- (4) 按“FAN SPEED”按钮使“地址数据”闪烁后，按“▲TEMP.”按钮或“▼TEMP.”按钮设定室内机地址数据。
(设定范围：00-63。)

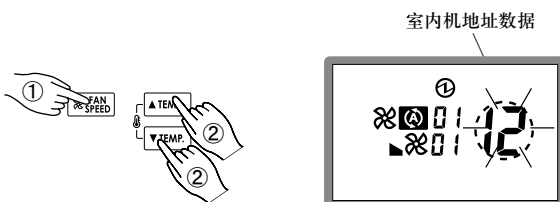

室内机地址数据

例) 选择了室内机地址数据“12”时。

- (5) 按“START/STOP”按钮确定室内机地址数据。(数据被传输到室内机)。

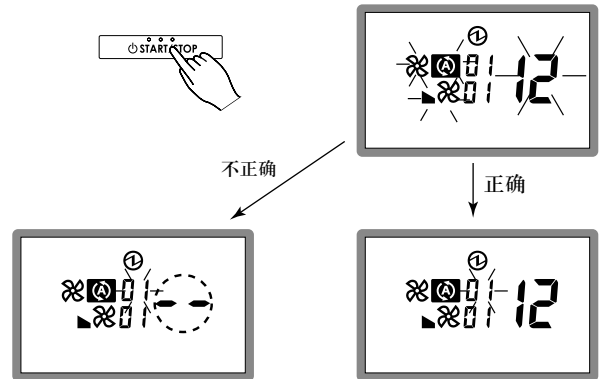

- 未在室内机中设定室内机地址数据时。(会显示 --)。
- 按照上述步骤 3-5 重新设定室内机地址数据。

在室内机中正确设定了室内机地址数据时。

- (6) 按“FAN SPEED”按钮使“地址代码”闪烁后，按“▲TEMP.”按钮或“▼TEMP.”按钮将地址代码设定为“02”。

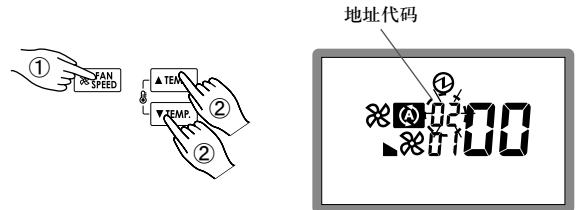

地址代码

制冷剂回路地址设定

- (7) “地址数据”显示闪烁。然后按“▲TEMP.”按钮或“▼TEMP.”按钮设定制冷剂回路地址数据。(设定范围：00-99。)

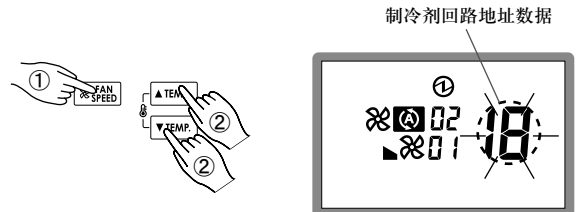

制冷剂回路地址数据

例) 选择了制冷剂回路地址“18”时。

- (8) 按“START/STOP”按钮确定制冷剂回路地址数据。(数据被传输到室内机)。

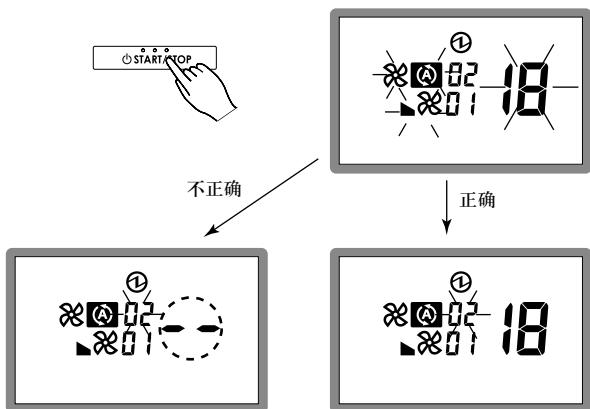

- 未在室内机中设定制冷剂回路地址数据时。(会显示-)。
- 按照上述步骤 8 重新设定制冷剂回路地址数据。

在室内机中正确设定了制冷剂回路地址数据时。

地址设定模式的结束

- (9) 如果同时按“▲TEMP.”按钮、“▼TEMP.”按钮和“FAN SPEED”按钮 5 秒钟以上，地址设定模式会被解除并返回到正常显示。

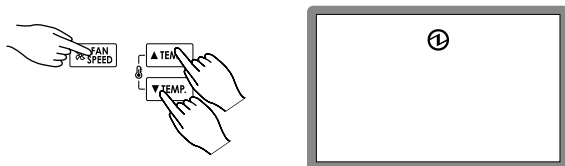

正常模式显示

- * 即使没有按上述按钮，如果在 60 秒钟内没有按下任何按键，地址设定模式将被自动解除。(进行地址设定时，如果按照上述步骤 1 的说明切换到地址设定模式，其会被自动解除。)

- (10) 完成功能设定后，请务必关闭电源再重新打开。

9. 功能设定

该步骤更改了根据安装情况用来控制室内机的功能设定。

不正确的设定可能导致室内机故障。

该步骤只能由授权的安装或维修人员进行操作。

使用遥控器根据安装情况执行“功能设定”。

- 有关功能编号和设定值的详细信息，请参阅室内机安装说明书。
- 开始功能设定前，参阅室内机的安装说明书为室内机的设定做好准备。

启动功能设定模式

- (1) 同时按“▲TEMP.”按钮、“▼TEMP.”按钮和“FAN SPEED”按钮 5 秒钟以上。切换到功能设定模式。

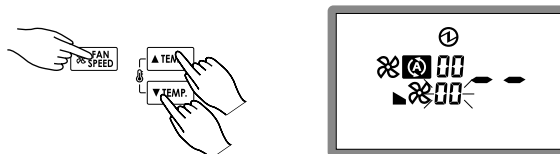

功能设定模式初始显示

- (2) 按“▲TEMP.”按钮或“▼TEMP.”按钮，然后选择遥控器地址 (选择相应的室内机)。

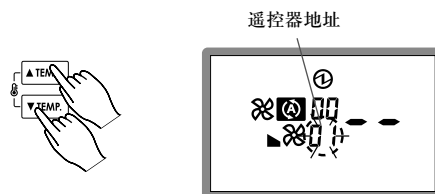

例) 选择了遥控器地址“01”时。

功能号码和设置号码设定

- (3) “功能号码”显示闪烁。然后按“▲TEMP.”按钮或“▼TEMP.”按钮显示号码。

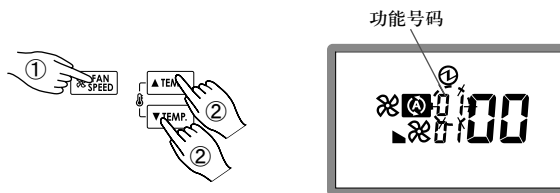

- (4) 按“FAN SPEED”按钮使“设置号码”闪烁后，按“▲TEMP.”按钮或“▼TEMP.”按钮设定设置号码。



例) 选择了设置号码“12”时。

- (5) 按“START/STOP”按钮确定设定。
(数据被传输到室内机)。

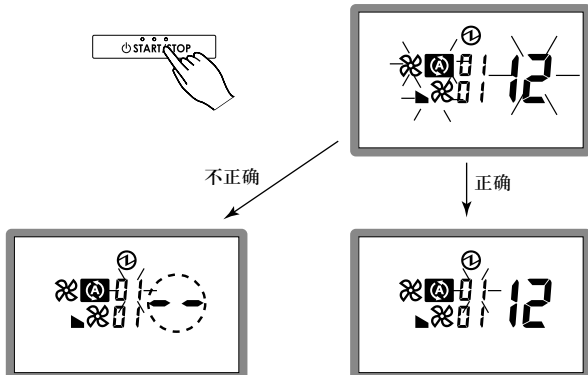

- 如果未设定室内机，则会显示“--”。
- 按照上述步骤 3-5 重新设定。

在室内机中正确设定时。

地址设定模式的结束

- (6) 如果同时按“▲TEMP.”按钮、“▼TEMP.”按钮和“FAN SPEED”按钮 5 秒钟以上，功能设定模式会被解除并返回到正常显示。

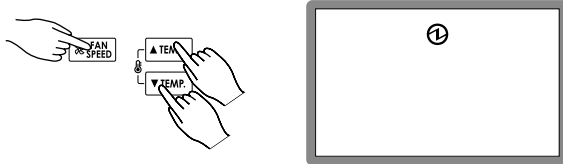

正常模式显示

* 即使没有按上述按钮，如果在 60 秒钟内没有按下任何按钮，功能设定模式将被自动解除。
(进行功能设定时，如果按照上述步骤 1 的说明切换到功能设定模式，其会被自动解除。)

- (7) 完成功能设定后，请务必关闭电源再重新打开。

10. 试运行

本机未启动试运行。可以通过其它遥控器启动试运行。
如果遥控器的显示屏闪烁显示 [Er]，请执行 [自检] 操作。

11. 故障代码显示

如果空调有问题，将停止运行，并显示“Er”。
如果出现故障，其会自动出现在显示屏。

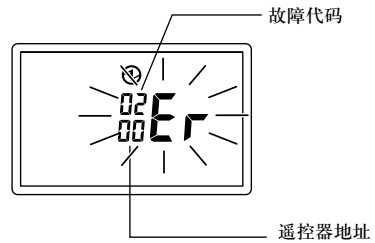

- 如果显示“Er”，请立即与授权的维修人员联系。
如果发生故障，请不要进行以下操作。
- 有关室内机的故障，请参阅室内机的安装说明书。

机组编号	故障代码	内容
00	15	连接了不兼容的室内机
00	12	室内机↔遥控器通信故障